



6146W

BEAM POWER TUBE

Small Size
High Power Gain
T-12 Bulb

For Use Under Severe Shock and Vibration
90 Watts CW Input (ICAS) up to 60 Mc
60 Watts CW Input (ICAS) at 175 Mc

3-13/16" Max. Length
1-21/32" Max. Diameter
Octal 8-Pin Base

TENTATIVE DATA

This bulletin also applies to RCA-6159W which is identical with RCA-6146W except for its heater rating of $26.5 \pm 10\%$ volts, 0.3 ampere. Heater-current range with 26.5 volts on heater is 0.28 to 0.32 ampere.

6159W

RCA-6146W is a small beam power tube designed specifically for applications where dependable performance under severe shock and vibration is

essential. It is intended for use as an rf power amplifier and oscillator as well as an af power amplifier and modulator.

The 6146W has a maximum plate dissipation of 25 watts under ICAS conditions in modulator service and in cw service. In the latter service, it can be operated with full input to 60 Mc and with reduced input to 175 Mc.

Because of its high power gain and high efficiency, the 6146W can be operated with relatively

low plate voltage to give large power output with small driving power.

Small in size for its power-output capability, the 6146W has a rugged button-stem construction with short internal leads, a T-12 bulb, triple base-pin connections for grid No.3 and cathode (both joined to internal shield inside the tube) to permit effective rf grounding, and a small-wafer octal base with metal sleeve having its own base-pin terminal. The sleeve shields the input to the tube and isolates it from the output circuit so completely that no other external shielding is required. Separation of input and output circuits is accomplished by bringing the plate lead out of the bulb to a cap opposite the base.



GENERAL DATA

Electrical:

Heater, for Unipotential Cathode:		
Voltage (AC or DC)	6.3 \pm 10%	volts
Current at 6.3 volts	1.25	amperes
Transconductance, for plate volts = 200, grid-No.2 volts = 200, and plate ma. = 100.		
	7000	μ hos
Mu-Factor, Grid No.2 to Grid No.1 for plate volts = 200, grid-No.2 volts = 200, and plate ma. = 100.		
	4.5	
Direct Interelectrode Capacitances:*		
Grid No.1 to plate	0.24 max.	μ f
Grid No.1 to cathode & grid No.3 & internal shield, base sleeve, grid No.2, and heater.	13.5	μ f
Plate to cathode & grid No.3 & internal shield, base sleeve, grid No.2, and heater.	8.5	μ f

Mechanical:

Operating Position	Any
Maximum Overall Length	3-13/16"
Seated Length.	3-1/8" \pm 1/8"
Maximum Diameter	1-21/32"
Bulb	T-12
Cap.	Small (JETEC No.C1-1)
Socket	Standard Octal 8-Contact
Base	Small Micanol-Wafer Octal 8-Pin "770" Sleeve (JETEC Group 1, No.BB-150)
Bulb Temperature (At hottest point).	220 max. °C
Weight (Approx.)	2 oz

AF POWER AMPLIFIER & MODULATOR--Class AB₁†

Triode Connection--Grid No.2 Connected to Plate
CCS* ICAS**

Maximum Ratings, Absolute Values:

DC PLATE VOLTAGE	400 max.	400 max.	volts
MAX.-SIGNAL DC PLATE CURRENT**	90 max.	90 max.	ma
MAX.-SIGNAL PLATE INPUT**	35 max.	35 max.	watts
PLATE DISSIPATION**	20 max.	25 max.	watts
PEAK HEATER-CATHODE VOLTAGE:			
Heater negative with respect to cathode	135 max.	135 max.	volts
Heater positive with respect to cathode	135 max.	135 max.	volts

Typical Operation:

Values are for 2 tubes

DC Plate Voltage	250	400	400	volts
DC Grid-No.1 Voltage	-50	-100	-100	volts
Peak AF Grid-No.1-to-Grid-No.1 Voltage ^o	100	200	200	volts
Zero-Signal DC Plate Current	120	40	40	ma





	CCS [•]		ICAS [•]		
Typical Operation (Cont'd):					
Max.-Signal DC Plate Current	125	100	100		ma
Effective Load Resistance (Plate to plate)	5000	8000	8000		ohms
Max.-Signal Driving Power (Approx.)	0	0	0		watts
Max.-Signal Power Output (Approx.)	10	22	22		watts

Maximum Circuit Values (CCS or ICAS):

Grid-No.1 Circuit Resistance under Any Condition: ^{OO} ⊕	
With fixed bias	0.1 max. megohm
With cathode bias	0.5 max. megohm

AF POWER AMPLIFIER & MODULATOR--Class AB₁†

Maximum Ratings, Absolute Values:

	CCS [•]		ICAS ^{••}		
DC PLATE VOLTAGE	600 max.		750 max.		volts
DC GRID-NO.2 (SCREEN) VOLTAGE	250 max.		250 max.		volts
MAX.-SIGNAL DC PLATE CURRENT**	125 max.		135 max.		ma
MAX.-SIGNAL PLATE INPUT**	60 max.		85 max.		watts
MAX.-SIGNAL GRID-NO.2 INPUT**	3 max.		3 max.		watts
PLATE DISSIPATION**	20 max.		25 max.		watts
PEAK HEATER-CATHODE VOLTAGE:					
Heater negative with respect to cathode	135 max.		135 max.		volts
Heater positive with respect to cathode	135 max.		135 max.		volts

Typical CCS Operation:

Values are for 2 tubes

DC Plate Voltage	400	500	600	volts
DC Grid-No.2 Voltage [▲]	190	185	180	volts
DC Grid-No.1 (Control-Grid) Voltage:				
With fixed-bias source	-40	-40	-45	volts
Peak AF Grid-No.1-to-Grid-No.1 Voltage	80	80	90	volts
Zero-Signal DC Plate Current	63	57	26	ma
Max.-Signal DC Plate Current	228	215	200	ma
Zero-Signal DC Grid-No.2 Current	2.5	2	1	ma
Max.-Signal DC Grid-No.2 Current	25	25	23	ma
Effective Load Resistance (Plate to plate)	4000	5500	7000	ohms
Max.-Signal Driving Power (Approx.)	0	0	0	watts
Max.-Signal Power Output (Approx.)	55	70	82	watts

Typical ICAS Operation:

Values are for 2 tubes

DC Plate Voltage	600	750	volts
DC Grid-No.2 Voltage [▲]	200	195	volts
DC Grid-No.1 (Control-Grid) Voltage:			
From fixed-bias source	-50	-50	volts
Peak AF Grid-No.1-to-Grid-No.1 Voltage	100	100	volts
Zero-Signal DC Plate Current	28	23	ma
Max.-Signal DC Plate Current	229	220	ma
Zero-Signal DC Grid-No.2 Current	1	1	ma
Max.-Signal DC Grid-No.2 Current	27	26	ma
Effective Load Resistance (Plate to plate)	6000	8000	ohms

Max.-Signal Driving Power (Approx.)	0	0	watts
Max.-Signal Power Output (Approx.)	95	120	watts

Maximum Circuit Values (CCS or ICAS):

Grid-No.1-Circuit Resistance under Any Condition: ^{OO} ⊕	
With fixed bias	0.1 max. megohm
With cathode bias	Not recommended

AF POWER AMPLIFIER & MODULATOR--Class AB₂#

Maximum Ratings, Absolute Values:

	CCS [•]		ICAS ^{••}		
DC PLATE VOLTAGE	600 max.		750 max.		volts
DC GRID-NO.2 (SCREEN) VOLTAGE	250 max.		250 max.		volts
MAX.-SIGNAL DC PLATE CURRENT**	125 max.		135 max.		ma
MAX.-SIGNAL PLATE INPUT**	62.5 max.		90 max.		watts
MAX.-SIGNAL GRID-NO.2 INPUT**	3 max.		3 max.		watts
PLATE DISSIPATION**	20 max.		25 max.		watts
PEAK HEATER-CATHODE VOLTAGE:					
Heater negative with respect to cathode	135 max.		135 max.		volts
Heater positive with respect to cathode	135 max.		135 max.		volts

Typical CCS Operation:

Values are for 2 tubes

DC Plate Voltage	400	500	600	volts
DC Grid-No.2 Voltage [▲]	175	175	165	volts
DC Grid-No.1 (Control-Grid) Voltage:				
From fixed-bias source	-41	-44	-44	volts
Peak AF Grid-No.1-to-Grid-No.1 Voltage	95	102	97	volts
Zero-Signal DC Plate Current	33	27	22	ma
Max.-Signal DC Plate Current	232	242	207	ma
Zero-Signal DC Grid-No.2 Current	1.1	0.7	0.6	ma
Max.-Signal DC Grid-No.2 Current	18	18	17	ma
Max.-Signal DC Grid-No.1 Current	1.6	1.9	1.1	ma
Effective Load Resistance (Plate to plate)	3700	4600	6800	ohms
Max.-Signal Driving Power (Approx.) [◆]	0.2	0.3	0.2	watt
Max.-Signal Power Output (Approx.)	62	83	90	watts

Typical ICAS Operation:

Values are for 2 tubes

DC Plate Voltage	600	750	volts
DC Grid-No.2 Voltage [▲]	190	165	volts
DC Grid-No.1 (Control-Grid) Voltage:			
From fixed-bias source	-48	-46	volts
Peak AF Grid-No.1-to-Grid-No.1 Voltage	109	108	volts
Zero-Signal DC Plate Current	28	22	ma
Max.-Signal DC Plate Current	270	240	ma
Zero-Signal DC Grid-No.2 Current	1.2	0.3	ma
Max.-Signal DC Grid-No.2 Current	20	20	ma
Max.-Signal DC Grid-No.1 Current	2	2.6	ma
Effective Load Resistance (Plate to plate)	5000	7400	ohms
Max.-Signal Driving Power (Approx.) [◆]	0.3	0.4	watt
Max.-Signal Power Output (Approx.)	113	131	watts

Maximum Circuit Values (CCS or ICAS):

Grid-No.1-Circuit Resistance: [◆]	
With fixed bias	30000 max. ohms
With cathode bias	Not recommended



**PLATE-MODULATED RF POWER AMPLIFIER--
Class C Telephony**

Carrier conditions per tube for use with
a max. modulation factor of 1.0

	CCS*	ICAS**	
Maximum Ratings, Absolute Values:			
DC PLATE VOLTAGE	480 max.	600 max.	volts
DC GRID-No.2 (SCREEN) VOLTAGE	250 max.	250 max.	volts
DC GRID-No.1 (CONTROL- GRID) VOLTAGE	-150 max.	-150 max.	volts
DC PLATE CURRENT	117 max.	125 max.	ma
DC GRID-No.1 CURRENT	3.5 max.	4.0 max.	ma
PLATE INPUT	45 max.	67.5 max.	watts
GRID-No.2 INPUT	2 max.	2 max.	watts
PLATE DISSIPATION	13.3 max.	16.7 max.	watts
PEAK HEATER-CATHODE VOLTAGE:			
Heater negative with respect to cathode	135 max.	135 max.	volts
Heater positive with respect to cathode	135 max.	135 max.	volts

Typical Operation up to 60 Mc:			
DC Plate Voltage	400	475	600
DC Grid-No.2 Voltage [†]	150	135	150
From a series resistor of	33000	51000	56000
DC Grid-No.1 Voltage*	-87	-77	-87
From a grid resistor of	27000	27000	27000
Peak RF Grid-No.1 Voltage	107	95	107
DC Plate Current	112	94	112
DC Grid-No.2 Current	7.8	6.4	7.8
DC Grid-No.1 Current (Approx.)	3.4	2.8	3.4
Driving Power (Approx.)	0.4	0.3	0.4
Power Output (Approx.)	32	34	52

Maximum Circuit Values (CCS or ICAS):			
Grid-No.1-Circuit Resistance [‡]			30000 max.

**RF POWER AMPLIFIER & OSC.--Class C Telegraphy[□]
and
RF POWER AMPLIFIER--Class C FM Telephony**

	CCS*	ICAS**	
Maximum Ratings, Absolute Values:			
DC PLATE VOLTAGE	600 max.	750 max.	volts
DC GRID-No.2 (SCREEN) VOLTAGE	250 max.	250 max.	volts
DC GRID-No.1 (CONTROL- GRID) VOLTAGE	-150 max.	-150 max.	volts
DC PLATE CURRENT	140 max.	150 max.	ma
DC GRID-No.1 CURRENT	3.5 max.	4.0 max.	ma
PLATE INPUT	67.5 max.	90 max.	watts
GRID-No.2 INPUT	3 max.	3 max.	watts
PLATE DISSIPATION	20 max.	25 max.	watts
PEAK HEATER-CATHODE VOLTAGE:			
Heater negative with respect to cathode	135 max.	135 max.	volts
Heater positive with respect to cathode	135 max.	135 max.	volts

Typical Operation as Amplifier up to 60 Mc:			
DC Plate Voltage	500	600	600 750
DC Grid-No.2 Voltage [†]	170	150	180 160
From a series resistor of	36000	51000	43000 56000
DC Grid-No.1 Voltage [‡]	-66	-58	-71 -62
From a grid-No.1 resistor of	27000	20000	24000 20000
From a cathode resistor of	470	470	430 470

	CCS*	ICAS**	
Peak RF Grid-No.1 Voltage	84	73	91 79
DC Plate Current	135	112	150 120
DC Grid-No.2 Current	9	9	10 11
DC Grid-No.1 Current (Approx.)	2.5	2.8	2.8 3.1
Driving Power (Approx.)	0.2	0.2	0.3 0.2
Power Output (Approx.)	48	52	66 70

Typical Operation as Amplifier at 175 Mc:			
DC Plate Voltage	320		400
DC Grid-No.2 Voltage ^{††}	180		190
From a series resistor of	13000		20000
DC Grid-No.1 Voltage [‡]	-51		-54
From a grid resistor of	27000		24000
From a cathode resistor of	330		330
Peak RF Grid-No.1 Voltage	64		68
DC Plate Current	140		150
DC Grid-No.2 Current	10		10.4
DC Grid-No.1 Current (Approx.)	2		2.2
Driving Power (Approx.)	3		3
Power Output (Approx.)	25		35

Maximum Circuit Values (CCS or ICAS):			
Grid-No.1 Circuit Resistance [‡]			30000 max.

CHARACTERISTICS RANGE VALUES FOR EQUIPMENT DESIGN

	Note	Min.	Max.	
Heater Current	1	1.175	1.325	amperes
Direct Interelectrode Capacitances:				
Grid No.1 to plate	2	-	0.24	μf
Grid No.1 to cathode & grid No.3 & internal shield, base sleeve, grid No.2, and heater	2	12.0	15.0	μf
Plate to cathode & grid No.3 & internal shield, base sleeve, grid No.2, and heater	2	7.3	9.5	μf
Plate Current	3	46	94	ma
Grid-No.2 Current	3	-	5.5	ma
Heater-Cathode Leakage Current:				
Heater 100 volts negative with respect to cathode	1	-	100	μa
Heater 100 volts positive with respect to cathode	1	-	100	μa
Useful Power Output	4	47	-	watts

- Note 1: With 6.3 volts ac on heater.
- Note 2: With no external shield.
- Note 3: With 6.3 volts ac on heater, dc plate voltage of 300 volts, dc grid-No.2 voltage of 200 volts, and dc grid-No.1 voltage of -33 volts.
- Note 4: In a single-tube, self-excited oscillator circuit, and with 6.3 volts ac on heater, dc plate voltage of 600 volts, dc grid-No.2 voltage of 180 volts, grid-No.1 resistor of 30000 ± 10% ohms, dc plate current of 100 - 112 ma., dc grid-No.2 current of 23 ma. maximum, dc grid-No.1 current of 2 to 2.5 ma., and frequency of 15 Mc.

- * With no external shield.
- † Subscript 1 indicates that grid-No.1 current does not flow during any part of the input cycle.
- Continuous Commercial Service.
- Intermittent Commercial and Amateur Service.
- ** Averaged over any audio-frequency cycle of sine-wave form.



- o The driver stage should be capable of supplying the No.1 grids of the class AB₁ stage with the specified driving voltage at low distortion.
- ∞ The type of input coupling network used should not introduce too much resistance in the grid-No.1 circuit. Transformer or impedance coupling devices are recommended.
- ⊕ When the 6146W is connected as a triode and its grid No.1 is operated with fixed bias, the dc grid-No.1 circuit resistance should never exceed the specified value of 0.1 megohm. If higher values of grid-No.1 circuit resistance are desired, cathode bias must be employed. Under no circumstances should the dc grid-No.1 resistance exceed the specified value of 0.5 megohm.
- ⊕ When the 6146W is operated as a beam power tube in class AB₁ service, only fixed bias should be used, and the dc grid-No.1 circuit resistance should never exceed the specified value of 0.1 megohm.
- ▲ Preferably obtained from a separate source or from the plate-voltage supply with a voltage divider.
- # Subscript 2 indicates that grid-No.1 current flows during some part of the input cycle.
- ◆ Driver stage should be capable of supplying the specified driving power at low distortion to the No.1 grids of the AB₂ stage. To minimize distortion, the effective resistance per grid-No.1 circuit of the AB₂ stage should be held at a low value. For this purpose, the use of transformer coupling is recommended. In no case, however, should the total dc grid-No.1-circuit resistance exceed 30000 ohms when the 6146W is operated at maximum ratings. For operation at less than maximum ratings, the dc grid-No.1-circuit resistance may be as high as 100000 ohms.
- ♠ Obtained preferably from a separate source modulated along with the plate supply or from the modulated plate supply through a series resistor.
- ★ Obtained from grid-No.1 resistor or from a combination of grid-No.1 resistor with either fixed supply or cathode resistor.
- ‡ When grid No.1 is driven positive and the 6146W is operated at maximum ratings, the total dc grid-No.1-circuit resistance should not exceed the specified value of 30000 ohms. If this value is insufficient to provide adequate bias, the additional required bias must be supplied by a cathode resistor or fixed supply. For operation at less than maximum ratings, the dc grid-No.1-circuit resistance may be as high as 100000 ohms.
- Key-down conditions per tube without amplitude modulation. Amplitude modulation essentially negative may be used if the positive peak of the audio-frequency envelope does not exceed 115% of the carrier conditions.
- ⊗ Obtained preferably from a separate source, or from the plate-supply voltage with a voltage divider, or through a series resistor. A series grid-No.2 resistor should be used only when the 6146W is used in a circuit which is not keyed. Grid-No.2 voltage must not exceed 400 volts under key-up conditions.
- Obtained from fixed supply, by grid-No.1 resistor, by cathode resistor, or by combination methods.

SPECIAL RATINGS AND PERFORMANCE DATA

Shock Rating:

This test is performed (per MIL-E-1C*, Par.4.9.20.5) on a sample lot of tubes from each production run. Tubes are held rigid and are subjected in four different positions to an impact acceleration of 500 g.

At the end of this test, tubes will not show permanent or temporary shorts or open circuits, and are required to meet the following limits:

Useful RF Power Output 42 min. watts
For conditions shown under *Characteristics Range Values, Note 4.*

Heater-Cathode
Leakage Current. .See *Characteristics Range Values*

The tubes must also meet the established limit for low-frequency vibration (see below).

Fatigue Rating:

This test is performed (per MIL-E-1C, par.4.9.20.6) on a sample lot of tubes from each production run. Tubes are rigidly mounted and subjected to 2.5 g vibrational acceleration at 25 cycles per second for 32 hours in each of three positions. At the end of this test, tubes will not show permanent or temporary shorts or open circuits, and are required to meet the following limits:

Useful RF Power Output 42 min. watts
For conditions shown under *Characteristics Range Values, Note 4.*

Heater-Cathode
Leakage Current. .See *Characteristics Range Values*

The tubes must also meet the established limit for low-frequency vibration (see below).

Low-Frequency Vibration Performance:

This test is performed (per MIL-E-1C, par.4.9.19.1) on a sample lot of tubes from each production run under the following conditions: Heater voltage of 6.3 volts, plate supply voltage of 250 volts, grid-No.2 voltage of 200 volts, grid-No.1 voltage varied to give a plate current of 10 milliamperes, plate load resistor of 2000 ohms, and vibrating frequency of 25 cycles per second with a fixed amplitude of 0.040 inch (total excursion 0.080 inch). The rms output voltage across the plate load resistor as a result of vibration of the tube must not exceed 500 millivolts.

Variable-Frequency Vibration Performance (1):

This test is performed (per MIL-E-1C, par.4.9.20.3) on a sample lot of tubes from each production run. Tubes are vibrated in each of 3 positions through frequency range of from 10 to 50 cycles per second and back to 10 cycles per second. The tubes are vibrated under the same conditions as specified for *Low-Frequency Vibration Performance*. During the test, the tubes will not show an rms output voltage across the plate load resistor in excess of 500 millivolts.

At the end of this test, the tubes will not show tap or permanent interelectrode shorts or defects that cause the tubes to be inoperable. The tubes will exhibit no pronounced mechanical resonance during this test.

Variable-Frequency Vibration Performance (2):

This test is performed on a sample lot of tubes from each production run. Tubes are vibrated in each of 3 positions, perpendicular and parallel to major axis of the tube, and parallel to longitudinal axis of the tube, through the frequency range from 50 to 120 cycles per second at a fixed acceleration of 10 g under the same voltage, current and load conditions as specified for *Low-Frequency Vibration Performance*.

During this test, the tubes will not show an rms output voltage across the plate load resistor in excess of 500 millivolts. The tubes will exhibit no pronounced mechanical resonance below 120 cycles per second during this test.

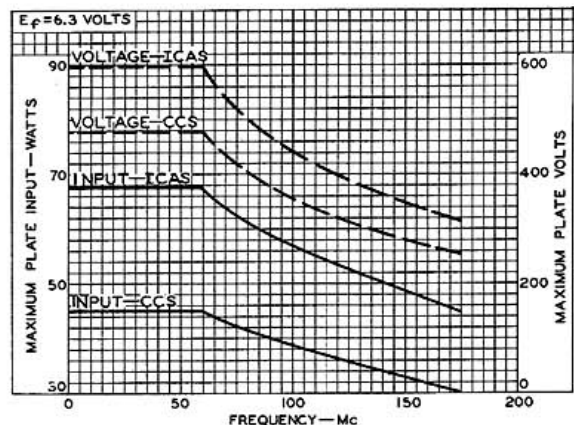

92CS-9614

Rating Chart I in Class C Telephony Service.

* 3 October 1955, Military Specification, Electron Tubes and Crystal Rectifiers.

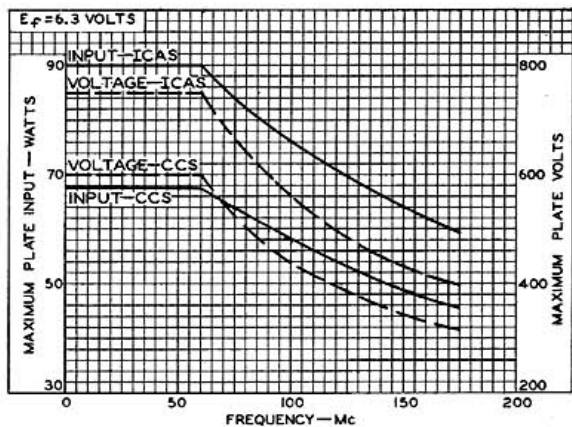

92CS-9615

Rating Chart II in Class C Telegraphy Service.

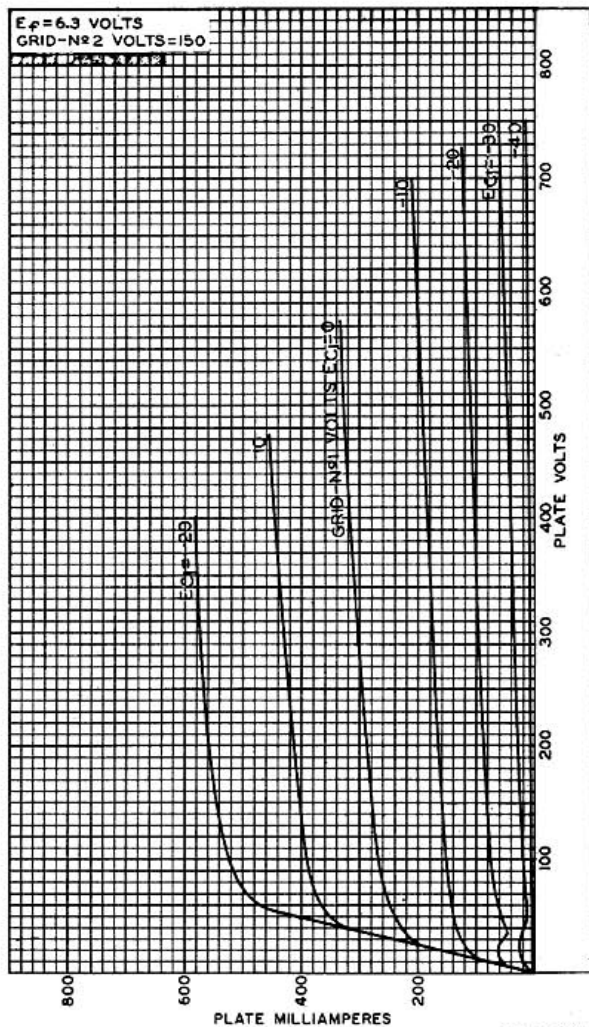

92CM-8145

Fig. 1 - Average Plate Characteristics.

OPERATING CONSIDERATIONS

The *maximum ratings* in the tabulated data are established in accordance with the following definition of the *Absolute-Maximum Rating System* for rating electron devices.

Absolute-Maximum ratings are limiting values of operating and environmental conditions applicable to any electron device of a specified type as defined by its published data, and should not be exceeded under the worst probable conditions.

The device manufacturer chooses these values to provide acceptable serviceability of the device, taking no responsibility for equipment variations, environment variations, and the effects of changes in operating conditions due to variations in device characteristics.

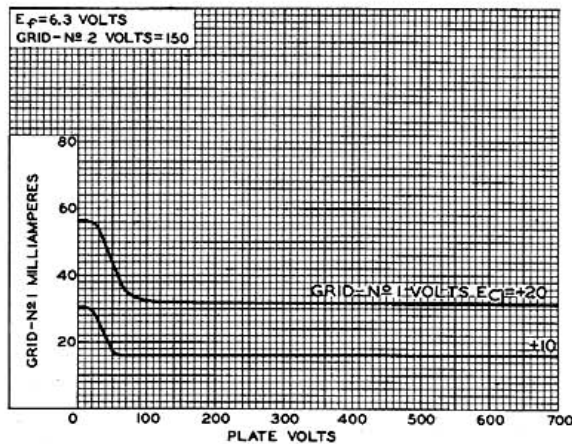

92CS-9619

Fig. 2 - Average Characteristics.

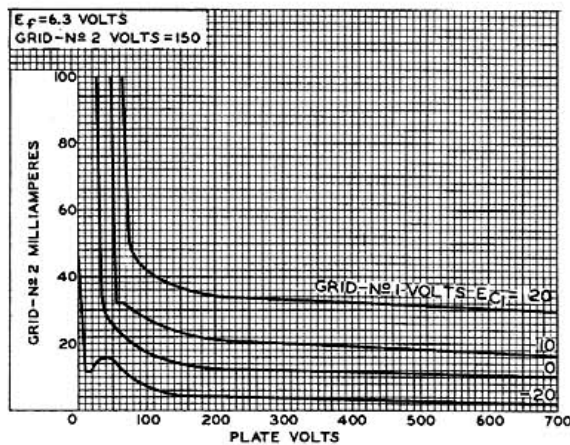

92CS-9620

Fig. 3 - Average Characteristics.



The equipment manufacturer should design so that initially and throughout life no absolute-maximum value for the intended service is exceeded with any device under the worst probable operating conditions with respect to supply-voltage variation, equipment component variation, equipment control adjustment, load variation,

signal variation, environmental conditions, and variations in device characteristics.

The rated plate voltage and grid-No.2 voltage of this tube are high enough to be dangerous to the user. Care should be taken during adjustment of circuits, especially when exposed circuit parts are at high dc potential.

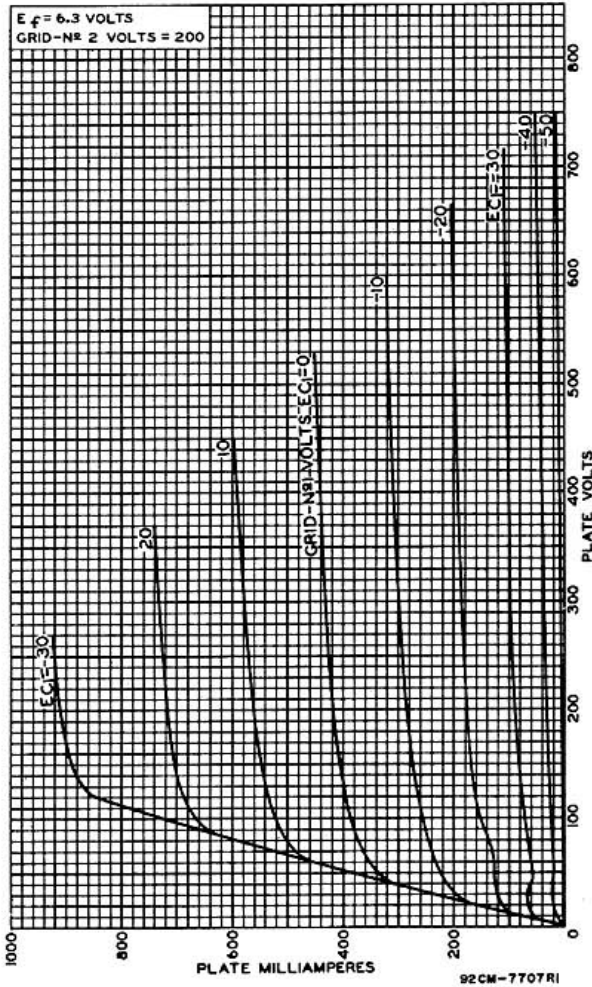

Fig. 4 - Average Plate Characteristics.

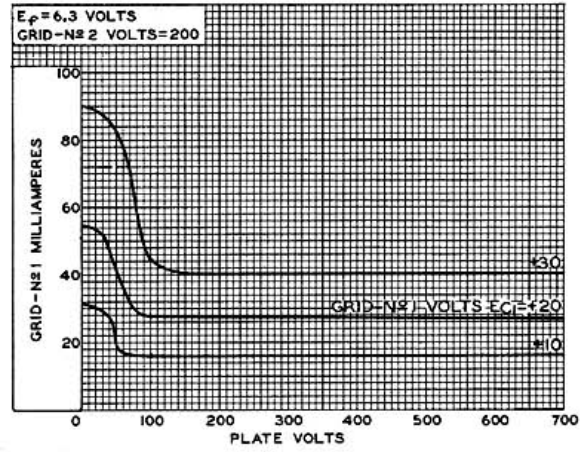

Fig. 5 - Average Characteristics.

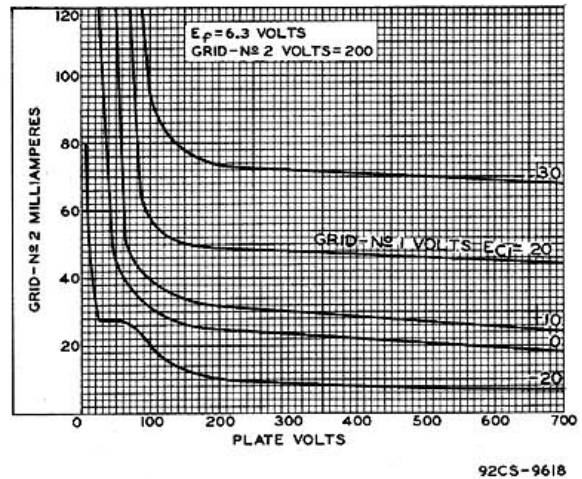

Fig. 6 - Average Characteristics.

Information furnished by RCA is believed to be accurate and reliable. However, no responsibility is assumed by RCA for its use; nor for any infringements of patents or other rights of third parties which may result from its use. No license is granted by implication or otherwise under any patent or patent rights of RCA.

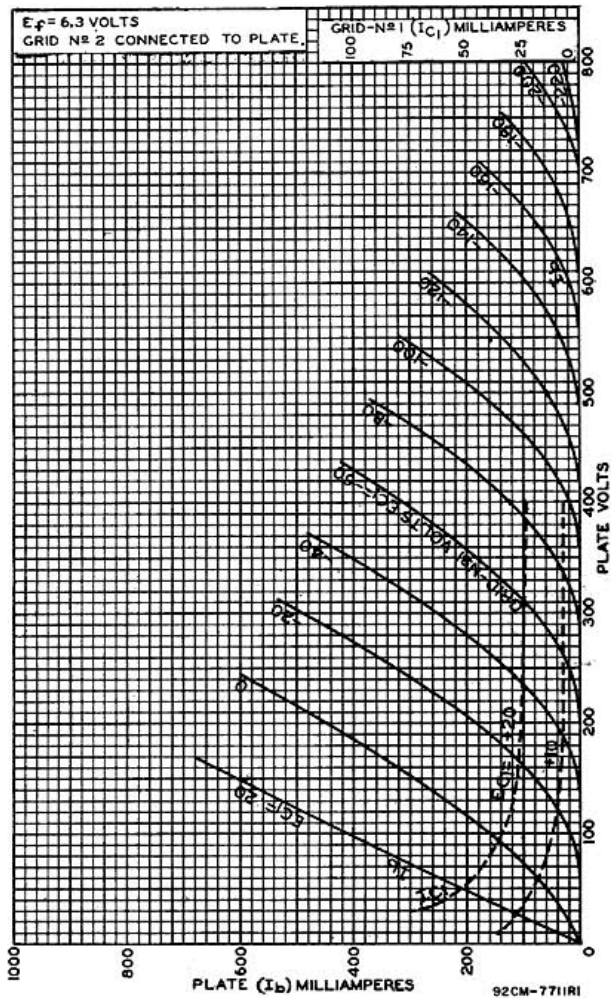
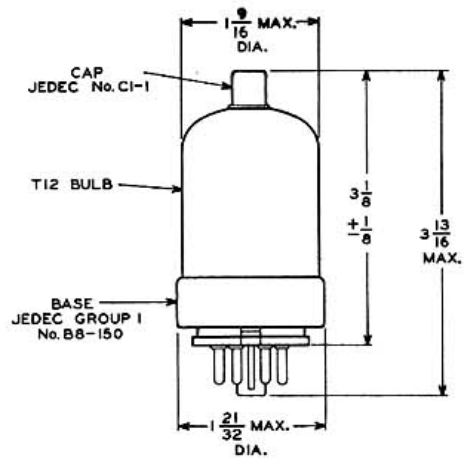

Fig. 7 - Average Characteristics with Triode Connection.

DIMENSIONAL OUTLINE



92CS-9625R4

DIMENSIONS IN INCHES

BASE DRAWING

SMALL-WAFER OCTAL WITH "770" SLEEVE
JEDEC GROUP 1, No. B8-150

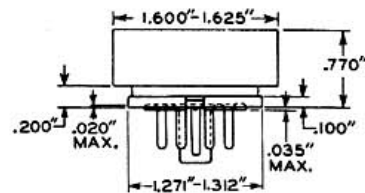

BASE-PIN POSITIONS ARE HELD TO TOLERANCES SUCH THAT ENTIRE LENGTH OF PINS WILL ENTER FLAT-PLATE GAUGE (JEDEC No. G88-1) HAVING THICKNESS OF 1/4" AND EIGHT HOLES WITH DIAMETERS OF 0.1030 ± 0.0005 " SO LOCATED ON A 0.6870 ± 0.0005 " DIAMETER CIRCLE THAT THE DISTANCE ALONG THE CHORD BETWEEN ANY TWO ADJACENT HOLE CENTERS IS 0.2629 ± 0.0005 ".

PIN FIT IN GAUGE IS SUCH THAT GAUGE TOGETHER WITH SUPPLEMENTARY WEIGHT TOTALING 2 POUNDS WILL NOT BE LIFTED WHEN PINS ARE WITHDRAWN.

SOCKET CONNECTIONS

Bottom View

- PIN 1: CATHODE, GRID No. 3, INTERNAL SHIELD
- PIN 2: HEATER
- PIN 3: GRID No. 2
- PIN 4: SAME AS PIN 1

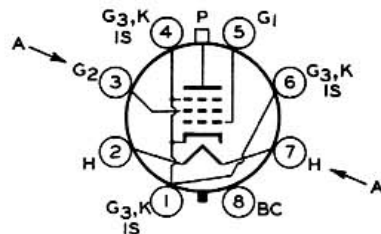

- PIN 5: GRID No. 1
- PIN 6: SAME AS PIN 1
- PIN 7: HEATER
- PIN 8: BASE SLEEVE
- CAP: PLATE

AA' = PLANE OF ELECTRODES

8EC