

Eitel
EITEL-McCULLOUGH, INC.
 SAN BRUNO, CALIFORNIA

3 5 T
 HIGH-MU TRIODE
 MODULATOR
 OSCILLATOR
 AMPLIFIER

GENERAL CHARACTERISTICS

ELECTRICAL

Filament: Thoriated tungsten		
Voltage - - - - -	5.0	volts
Current - - - - -	4.0	amperes
Amplification Factor (Average) - - - - -		39
Direct Interelectrode Capacitances (Average)		
Grid-Plate - - - - -	1.8	$\mu\mu\text{f}$
Grid-Filament - - - - -	4.1	$\mu\mu\text{f}$
Plate-Filament - - - - -	0.3	$\mu\mu\text{f}$
Transconductance ($I_b=100 \text{ ma.}, E_b=2000, e_c=-30$)	2850	μmhos
Frequency for Maximum Ratings - - - - -	100	mc.

MECHANICAL

Base - - - - -	(Medium 4-pin bayonet, ceramic)	RMA type M8-078
Basing - - - - -		RMA type 3G
Maximum Overall Dimensions:		
Length - - - - -		5.5 inches
Diameter - - - - -		1.81 inches
Net weight - - - - -		2.5 ounces
Shipping weight (Average) - - - - -		1.25 pounds

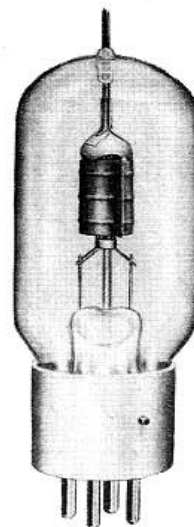

AUDIO FREQUENCY POWER AMPLIFIER AND MODULATOR
Class B

	TYPICAL OPERATION—2 TUBES			MAX. RATING	
	1000	1500	2000		
D-C Plate Voltage - - - - -	1000	1500	2000	2000	volts
Max.-Signal D-C Plate Current, per tube* - - -	•	•	•	150	ma.
Plate Dissipation, per tube* - - - - -	•	•	•	50	watts
D-C Grid Voltage (approx.) - - - - -	-8	-25	-40		volts
Peak A-F Grid Input Voltage - - - - -	240	250	255		volts
Zero-Signal D-C Plate Current - - - - -	67	45	34		ma.
Max.-Signal D-C Plate Current - - - - -	240	200	167		ma.
Max.-Signal Driving Power (approx.) - - - - -	7	5	4		watts
Effective Load, Plate-to-Plate - - - - -	7900	16200	27500		ohms
Max.-Signal Plate Power Output - - - - -	140	200	235		watts

*Averaged over any sinusoidal audio frequency cycle.

RADIO FREQUENCY POWER AMPLIFIER AND OSCILLATOR
Class-C *Telegraphy
 (Key down conditions without modulation)

	TYPICAL OPERATION—1 TUBE			MAX. RATING	
	1000	1500	2000		
D-C Plate Voltage - - - - -	1000	1500	2000	2000	volts
D-C Plate Current - - - - -	125	125	125	150	ma.
D-C Grid Current - - - - -	40	40	45	50	ma.
D-C Grid Voltage - - - - -	-60	-120	-135		volts
Plate Power Output - - - - -	87	141	200		watts
Plate Input - - - - -	125	188	250		watts
Plate Dissipation - - - - -	38	47	50	50	watts
Peak R. F. Grid Input Voltage, (approx.) - - -	165	250	285		volts
Driving Power, (approx.) - - - - -	7	9	13		watts

*The above figures show actual measured tube performance, and do not allow for variations in circuit losses.

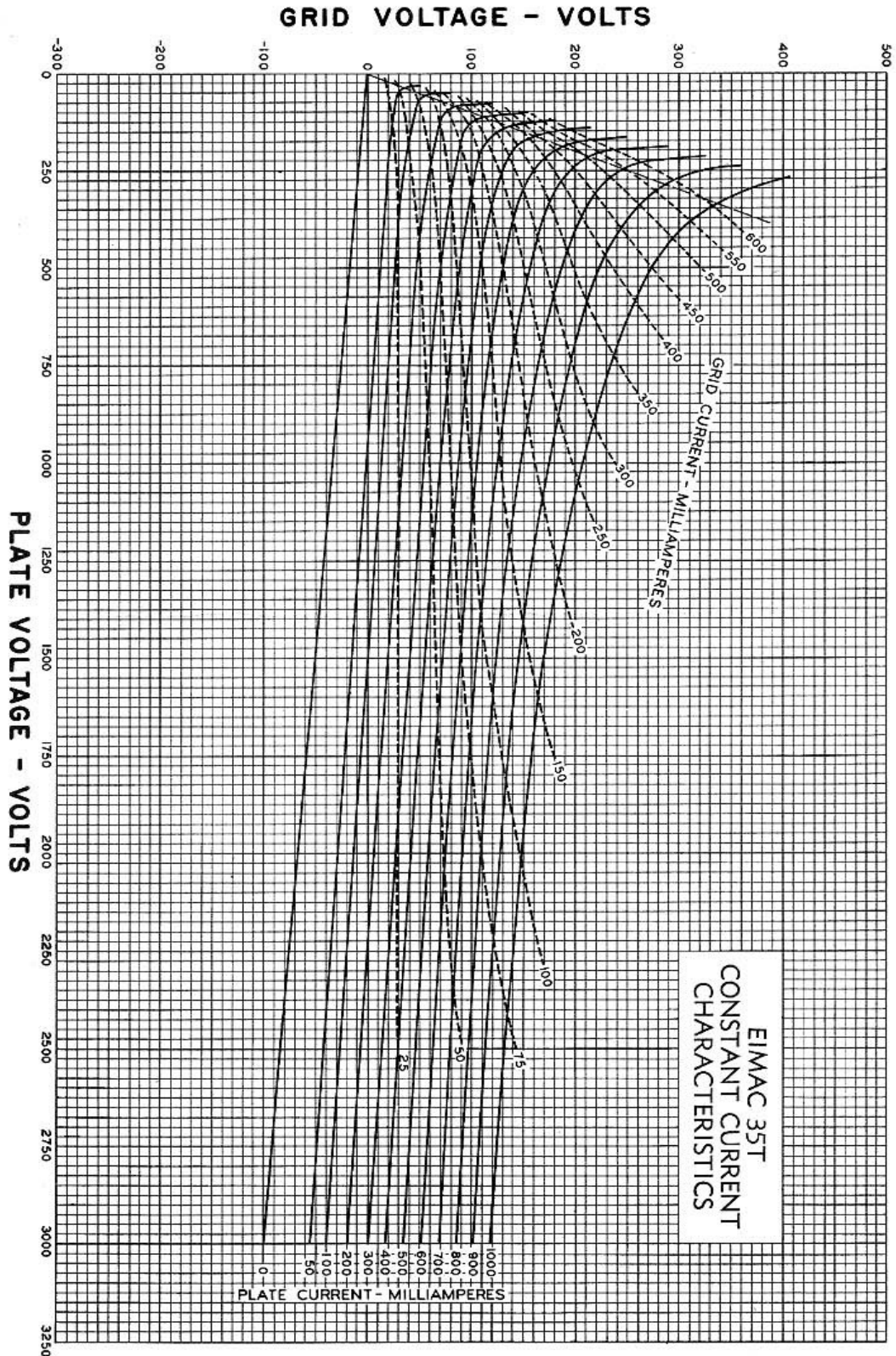

DRIVING POWER vs. POWER OUTPUT

The three charts on this page show the relationship of plate efficiency, power output and grid driving power at plate voltages of 1000, 1500 and 2000 volts. These charts show combined grid and bias losses only. The driving power and power output figures do not include circuit losses. The plate dissipation in watts is indicated by P_p .

Points A, B, and C are identical to the typical Class C operating conditions shown on the first page under 1000, 1500, and 2000 volts respectively.

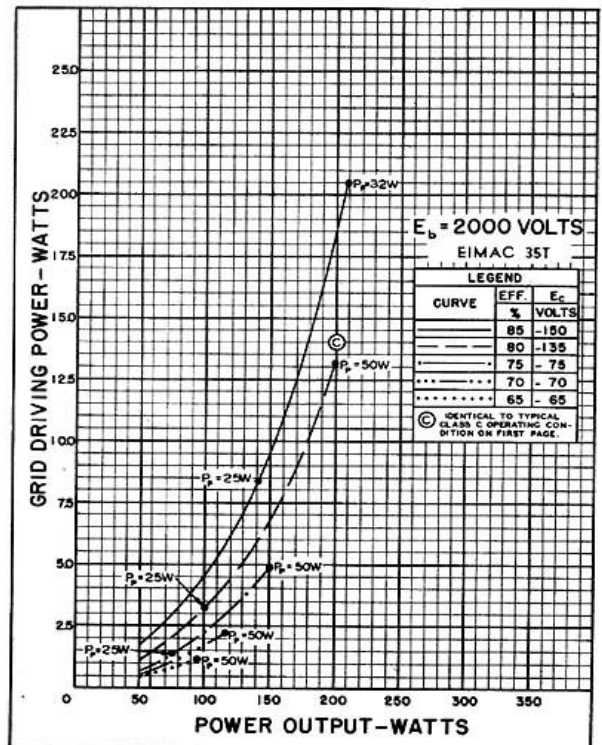
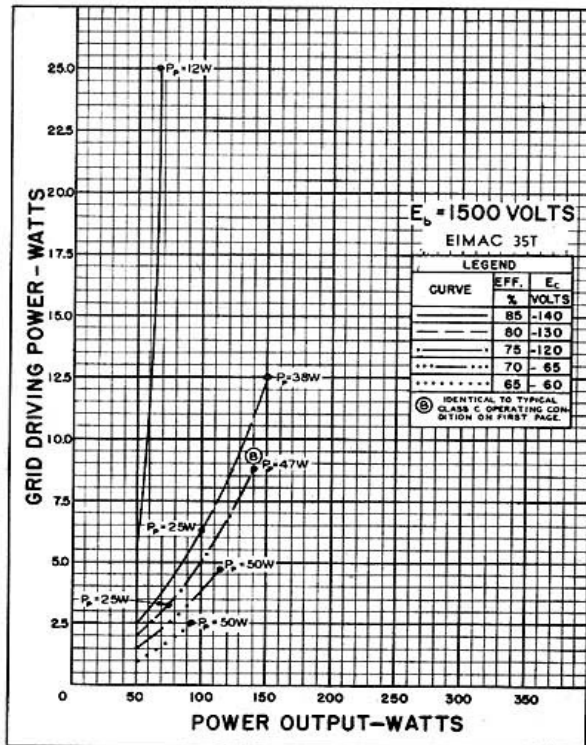
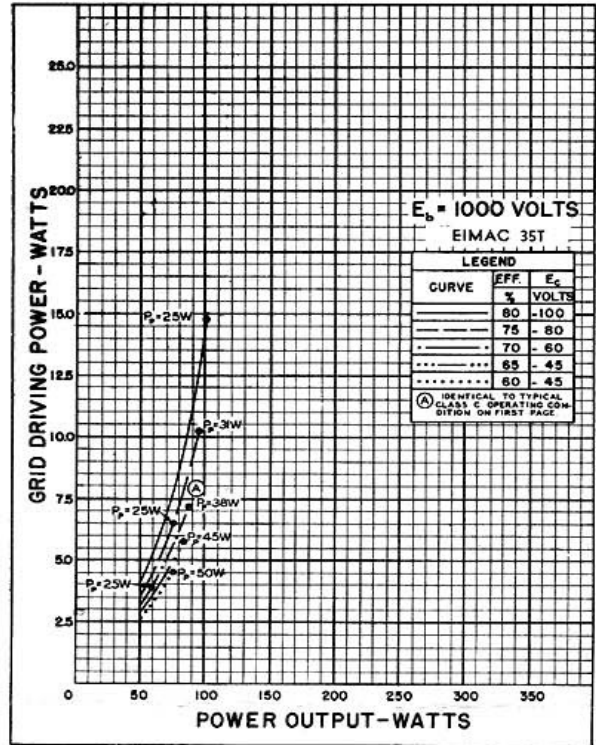

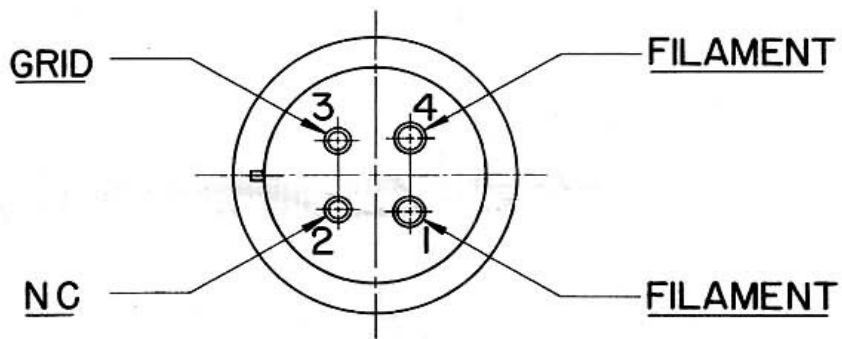
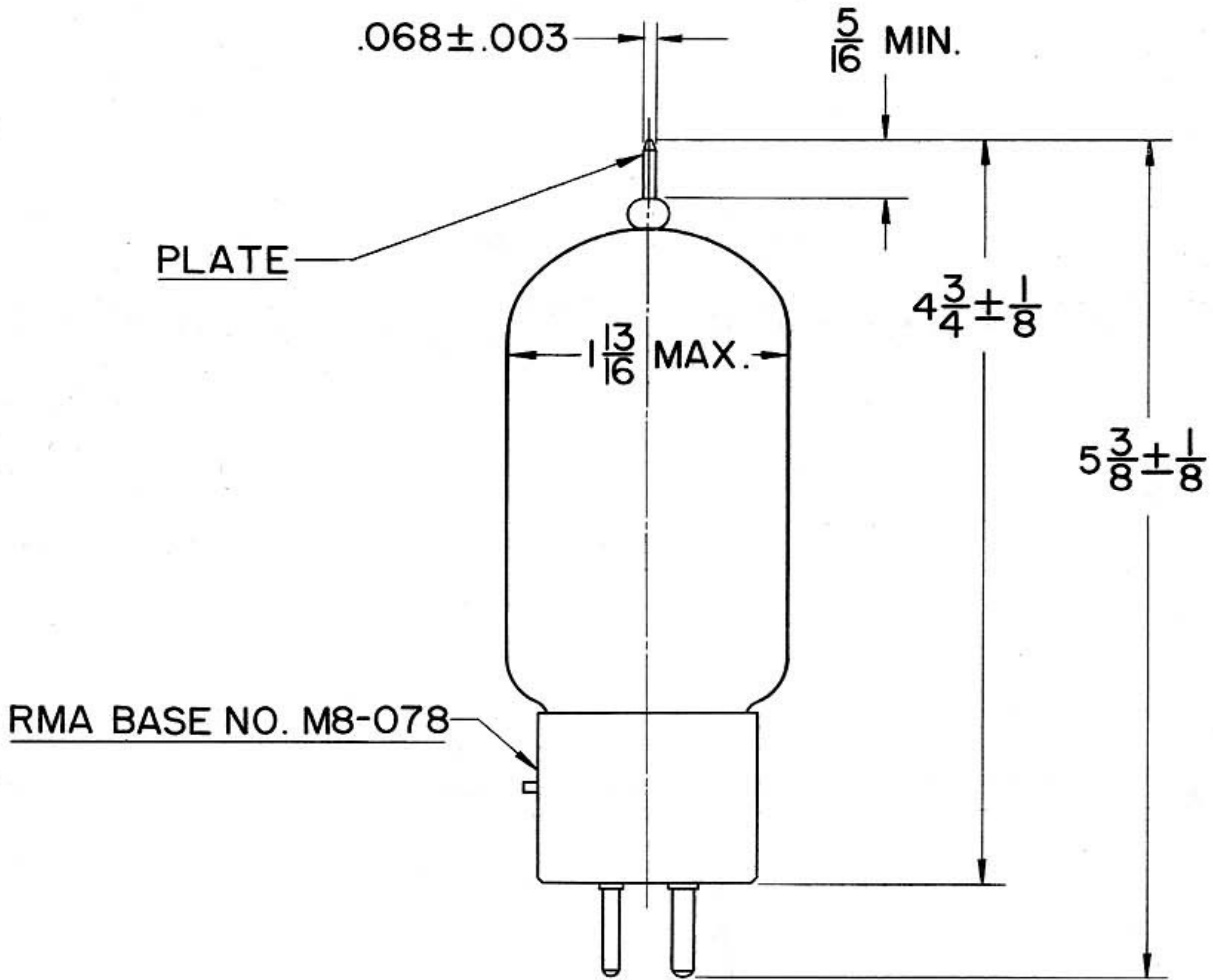

36

